

PUBLIC SPACES FOR THE GRUNEWALD DISCTRCT, KIRCHBERG, LUXEMBOURG 格吕内瓦尔德区公共空间设计

Landscape Architects: OKRA Landscape Architects by
Client: Fonds d'urbanisation et d'aménagement du Plateau de Kirchberg
Location: Kirchberg, Luxemburg, Germany
Size: 28,000 m²
Photographer: OKRA

设计公司：OKRA 景观设计师事务所
客户：基希贝格高原城镇规划局
地点：德国卢森堡基希贝格
面积：28 000 m²
摄影师：OKRA

SITE

This design is for the public spaces for the Grunewald district, Kirchberg, Luxembourg. The assignment was to create public spaces between apartment buildings, just like a fragmented orchard.

概况

该项目位于卢森堡基希贝格市的格吕内瓦尔德区，旨在为公寓楼之间创造环境怡人的公共空间，如同果园一角。

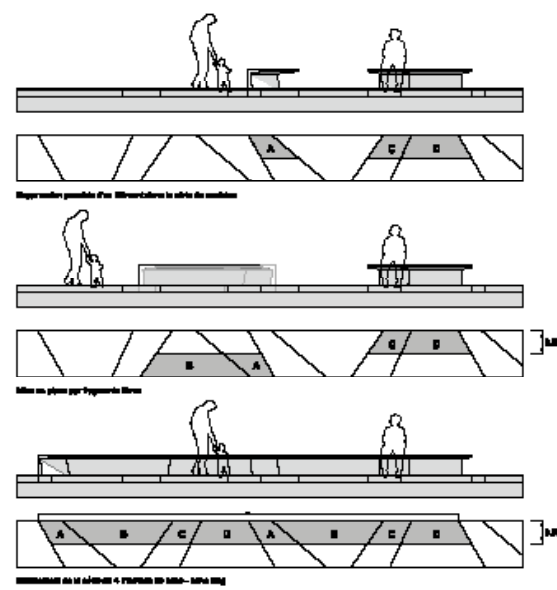

FRAGMENTS

The orchard stands in a fragmented layout of squares and passages organized in a grid system together with buildings and private parcels. The jury awarded the strong identity that the project introduces for this part of the Plateau of Kirchberg and also the gesture towards the rigid atmosphere of the buildings. A gradual change in the types and the densities of plantation creates a high quality link between the higher part of the district, more business and urban a-like, and the southern part, more natural, leading towards the Klosengroendchen park. Different atmospheres of orchard are created to provide a specific sense of place to each areas of the new district. A network of lines binds the different pieces of public space in order to create a narrative and spatial link between each of the existing public spaces fragments.

片段

“果园”呈片段式布局，广场和通道与周围的建筑和私人空间连接，形成网格状。该设计之所以能最终胜出，正是由于它不仅与基希贝格高原城镇规划概念一致，而且与周围的建筑氛围相融合。种植的种类和密度不断变化，使之既能与北侧的商业高地相融，又能自然过渡到南侧 losengroendchen 公园的自然氛围。不同的“片段”洋溢着不同的氛围，通过流畅的网格线条相互连接，形成一个完整的景观区域。

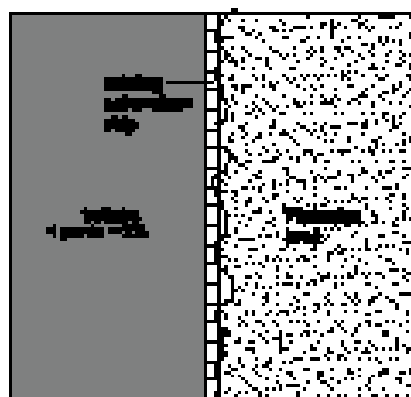
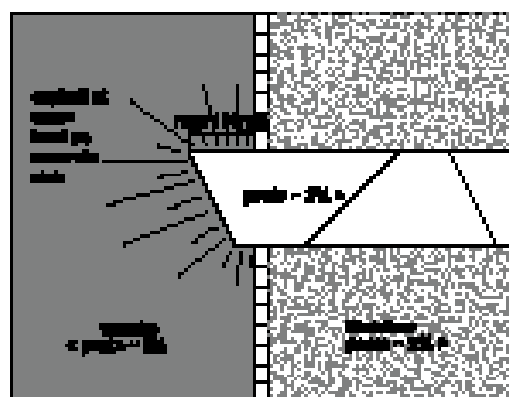
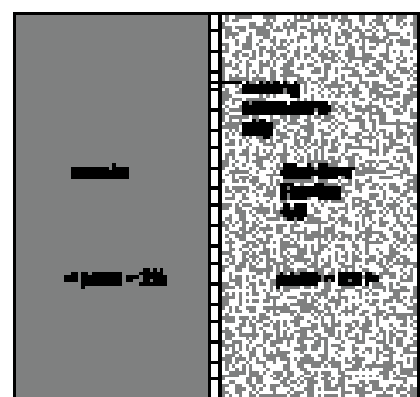
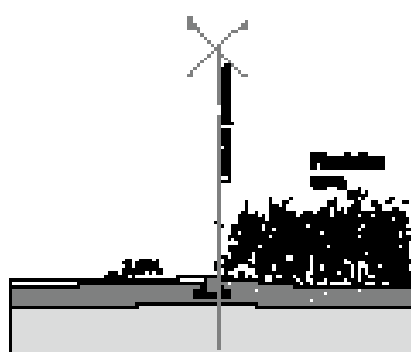
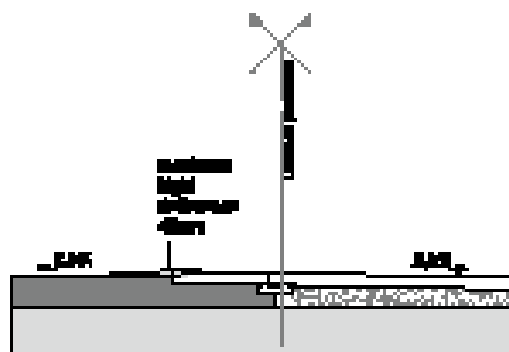
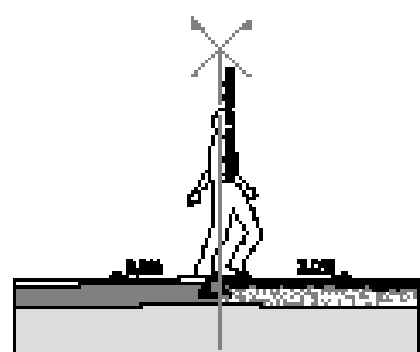



194

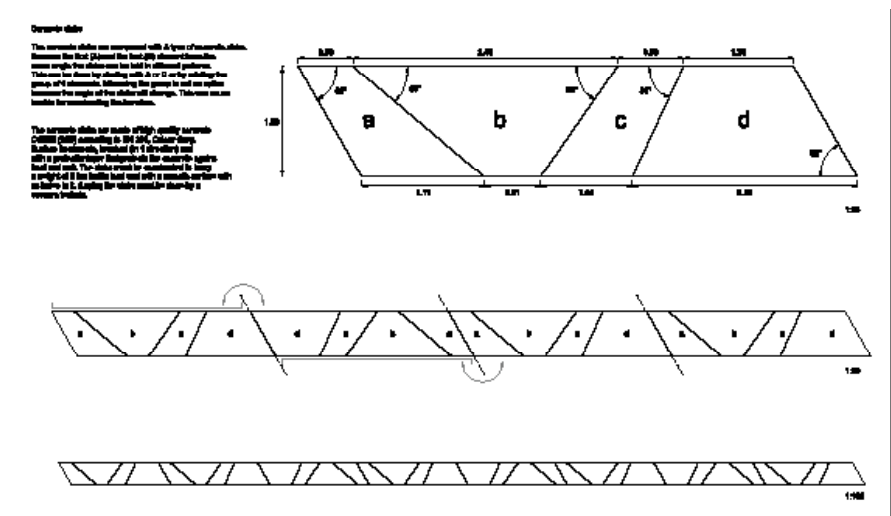
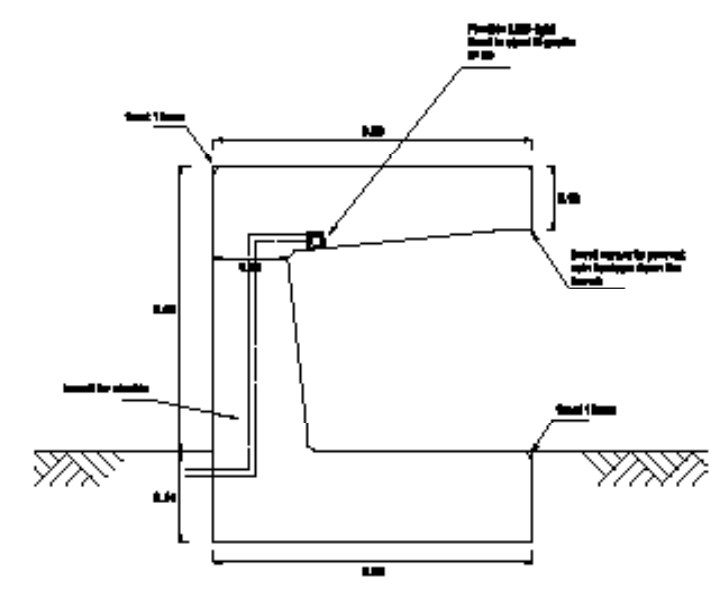
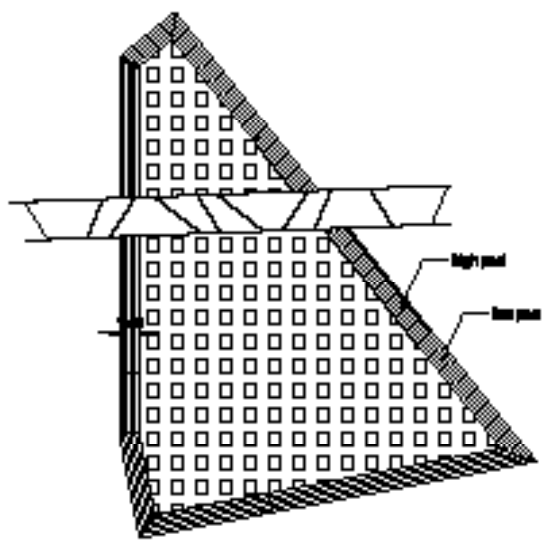
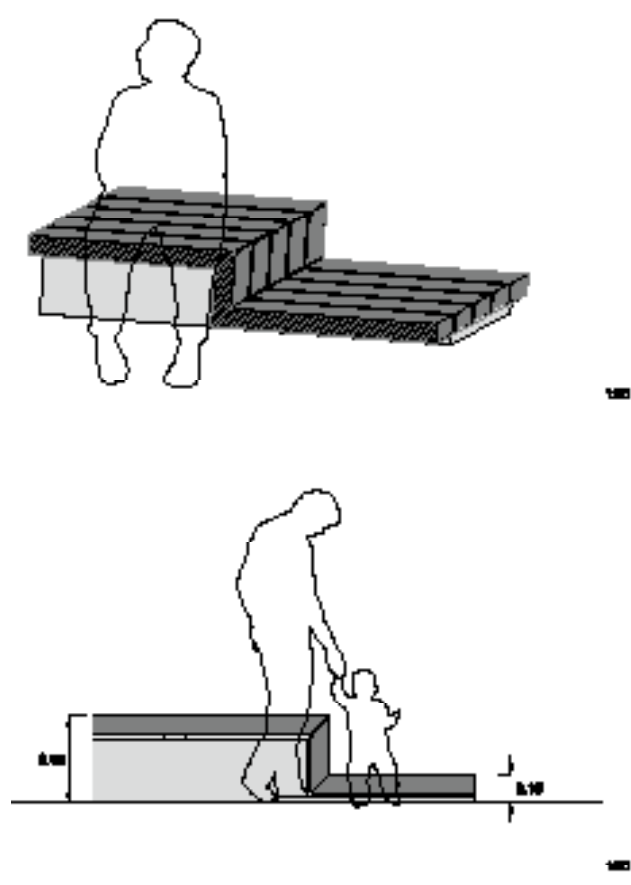

195

